

Article number: 201471V502SW

Description: E+G Tube connector - GN 147.1-V50-2-SW

Measures

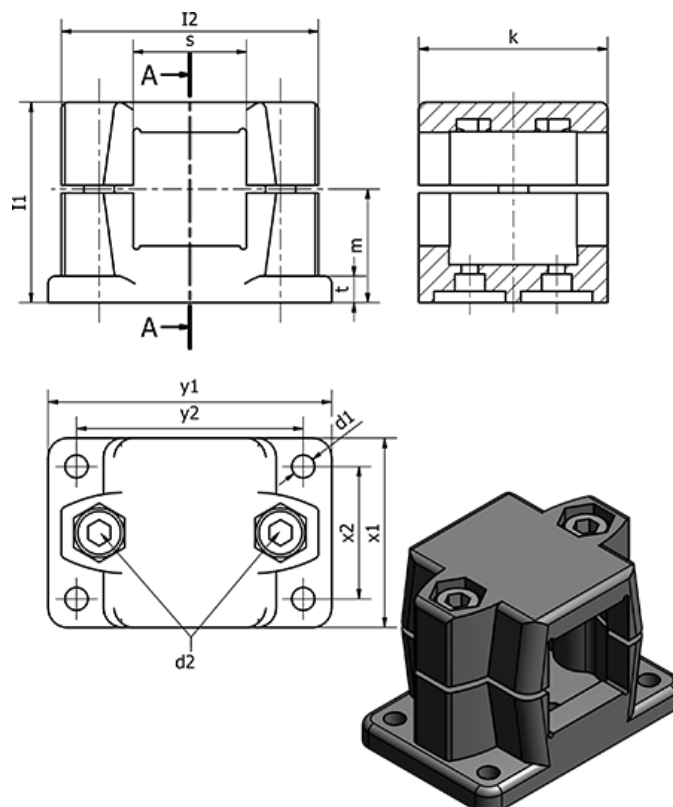

Clamping kit for d3 = GN 911-M10-70

d1 = 11
 d2 = M10
 d3 = M6
 l1 = 81.5
 l2 = 98
 k = 76
 m = 46.5

s = V50
 t = 14
 Weight (g) = 595
 x1 = 76
 x2 = 50
 y1 = 115
 y2 = -